

# HBO500W

Campana LED Redonda 500W

## Producto



## Dimensiones

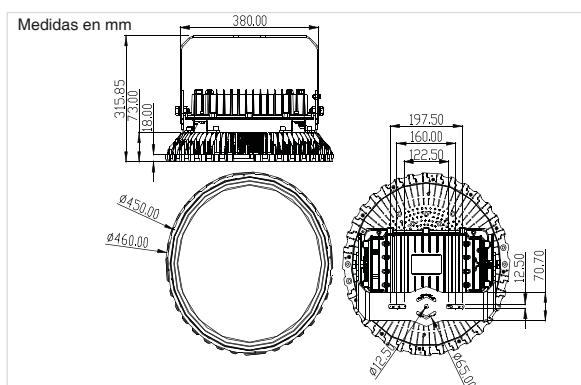

## Datos Técnicos

Entrada:	110~240Vac 50/60Hz
Potencia:	500W
Nº de LEDs:	770 chips SMD3030 PHILIPS
Factor Potencia:	>0.90
Eficiencia Lumínica:	125 lm/w
Potencia LED:	0.65W
Flujo Luminoso:	62500 lm (BF) 61600 lm (BN) 60900 lm (BC)
Intensidad Lumínica:	20207cd
Grado de IP:	IP65
Temp. Trabajo:	-20°C +50°C
Nº Conmutaciones:	30.000
Certificaciones:	CE, RoHS
Eficiencia Energética:	A+
Vida útil:	50.000h (L70:B10)
Regulación:	Si, MEAN WELL (Opcional)
Peso:	7,270 gramos

## Datos Fotométricos

**Ángulo de apertura** =30°, 90°, 120°  
**Flujo Luminoso** =62500 lm  
**Tª de color CCT** =5500K (BF)  
**CRI** =>80

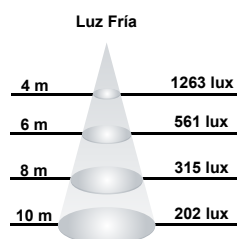
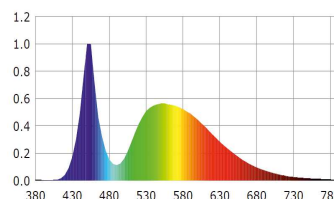

**Ángulo de apertura** =30°, 90°, 120°  
**Flujo Luminoso** =61600 lm  
**Tª de color CCT** =4000K (BN)  
**CRI** =>80

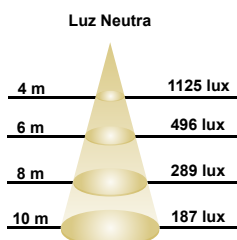
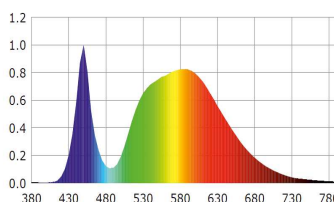

**Ángulo de apertura** =30°, 90°, 120°  
**Flujo Luminoso** =60900 lm  
**Tª de color CCT** =3000K (BC)  
**CRI** =>80

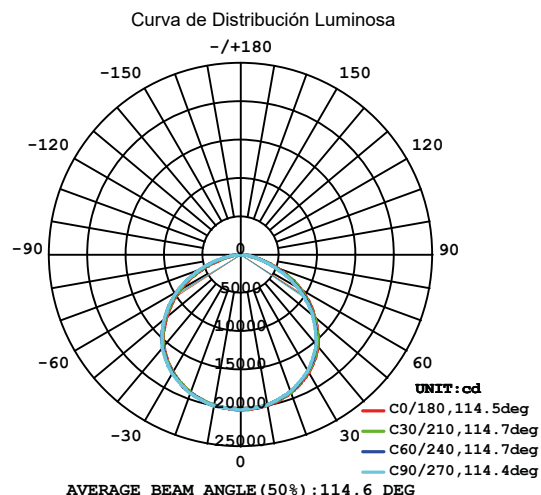
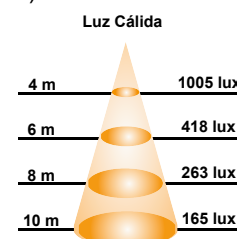
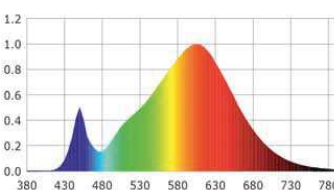

Chip utilizado

